

ELENCO PARTI / PARTS LIST

#	QTÀ / QTY	DESCRIZIONE / DESCRIPTION	CODICE / CODE
1	1	DB killer / DB killer	50.DK.020.0
2	1	Silenziatore / Muffler	GP
3	1	Protezione in gomma per staffa / Rubber protection for bracket	50.73.077.1
4	1	Staffa / Bracket	50.SS.241.1
5	2	Dado M6 / Nut M6	50.72.038.1
6	4	Rondella M6 / Washer M6	50.72.027.1
7	2	Vite M6 x 12 / Screw M6 x 12	50.72.024.1
8	1	Dado 8 MA flangiato / Flanged nut 8 MA	50.73.052.1
9	1	Rondella in alluminio / Aluminium washer	50.73.063.1
10	1	Vite M8x50 / Screw M8x50	50.73.074.1
11	1	Tubo di raccordo / Link pipe	9773S029S2
12	1	Gommino paracolpi / Rubber buffer	50.72.010.1
13	1	Fascetta Ø 56/59 mm / Pipe clamp Ø 56/59 mm	50.FA.009.1
14	1	Tubo in gomma per molla / Rubber pipe for spring	50.73.049.0
15	1	Molla / Spring	50.71.080.1

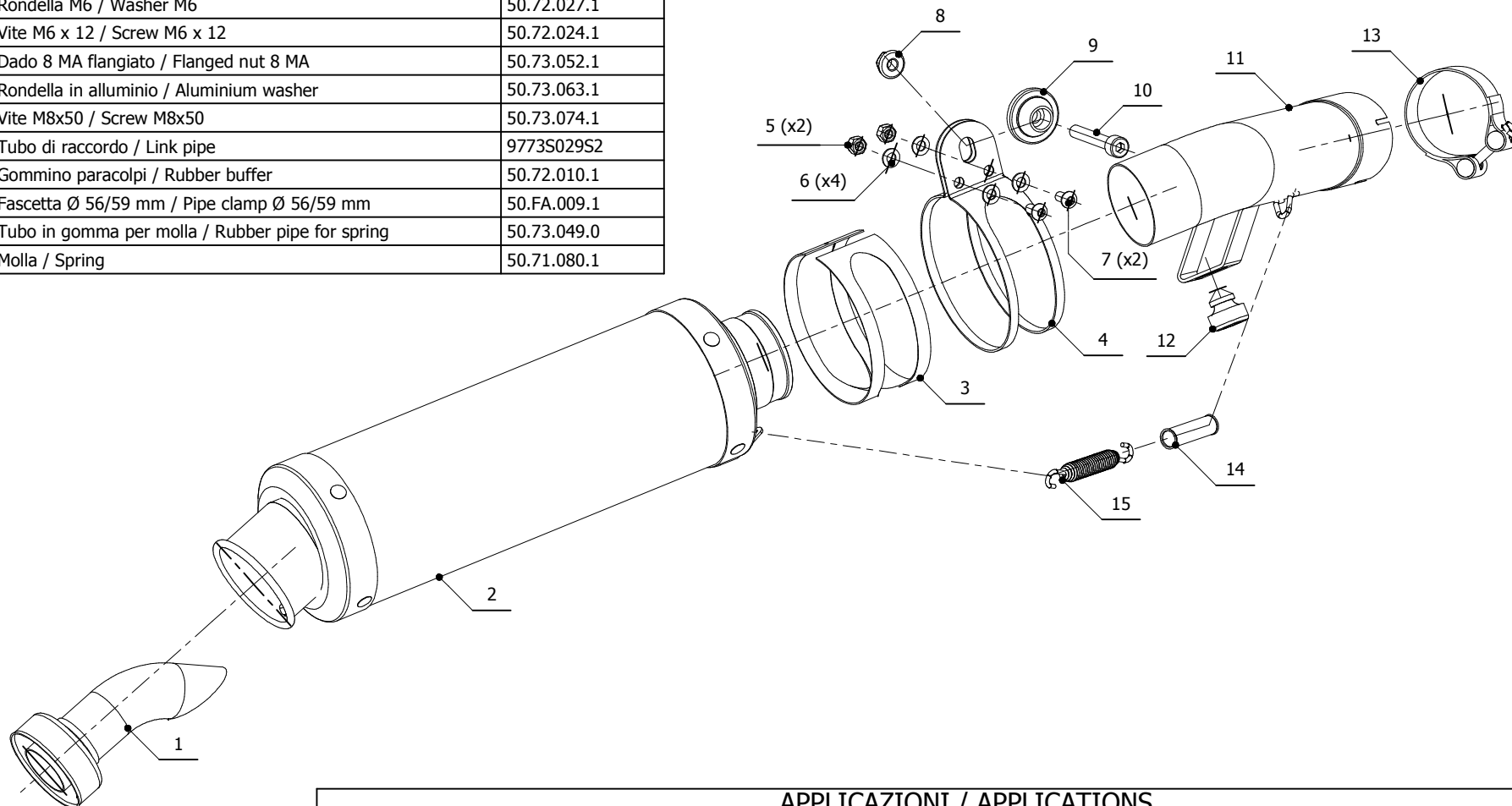

APPLICAZIONI / APPLICATIONS

CODICE / CODE	TUBO / PIPE	SILENZIATORE / MUFFLER	FASCETTA / CLAMP	CODICE OMOL. / HOMOL. CODE
74.S.029.LXS	INOX / ST. STEEL	INOX / ST. STEEL	INOX / ST. STEEL	ME002 e9 1177